

Metolachlor ELISA, Microtiter Plate
Enzyme-Linked Immunosorbent Assay for the Determination
of Metolachlor in Contaminated Samples



Product No. 500065

Importance of Metolachlor Determination

Metolachlor is one of the most widely used herbicides in agriculture throughout the world. It is a pre-emergence herbicide used on a variety of crops including corn, soybeans, peanuts and cotton. An aniline derivative and member of the chloracetanilide family of herbicides, Metolachlor was originally produced as a mixture of the S- and R-isomers (only the S-isomer is active). Modern production methods produce only the S-isomer. Metolachlor may be used alone or in combination with other herbicides. Metolachlor readily leaches into run-off and has been found in both surface and ground waters.

The Abraxis Metolachlor ELISA allows the determination of 40 samples in duplicate determination. Only a few milliliters of sample are required. The test can be performed in less than 1 hour.

Performance Data

Test sensitivity: The limit of detection for Metolachlor, calculated as 90% B/Bound, is approximately 0.058 ng/mL. The concentration of residue necessary to cause 50% inhibition (50% B/B₀) is approximately 1.6 ng/mL. Determinations closer to the middle of the calibration range of the test yield the most accurate results.

Test reproducibility: Coefficients of variation (CVs) for standards: <10%; CVs for samples: <15%.

Recoveries: Five (5) groundwater samples were spiked with various levels of Metolachlor and assayed using the Abraxis Metolachlor Plate ELISA. The following results were obtained:

Metolachlor Added (ppb)	Mean Recovery (ppb)	S.D. (ppb)	% Recovery
0.5	0.52	0.04	104
1.0	1.08	0.10	108
2.0	2.22	0.15	111
3.0	3.33	0.25	111
4.0	4.19	0.32	105
Average			108

Selectivity: This ELISA recognizes Metolachlor and related acetanilides to varying degrees:

Cross-Reactivity:	Metolachlor	100%
	Metolachlor S	100%
	Acetochlor	9%
	Butachlor	9%
	Alachlor	3%
	Metalaxyl	1%

The following compounds demonstrated no reactivity in the Abraxis Metolachlor Plate ELISA at concentrations up to 1000ppb: Aldicarb, Aldicarb Sulfate, Aldicarb Sulfone, Atrazine, Ametryn, Benomyl, Butylate, Captan, Carbaryl, Carbendazim, Carbofuran, Cyanazine, 2,4-D, 1,3-dichloropropene, Dinoseb, MCPA, Metribuzin, Pentachlorophenol, Picloram, Propazine, Simazine, Terbufos, Thiabendazole, and Thiophanate-methyl.

General Limited Warranty: Abraxis LLC warrants the products manufactured by the Company against defects and workmanship when used in accordance with the applicable instructions for a period not to extend beyond the product's printed expiration date. **Abraxis makes no other warranty, expressed or implied. There is no warranty of merchantability or fitness for a particular purpose.**

For ordering or technical assistance contact:

India Contact:

Life Technologies (India) Pvt. Ltd.

306, Aggarwal City Mall, Road No. 44, Pitampura, Delhi - 110034, India

Mobile: +91-98105-21400, Tel: +91-11-42208000, 8111, 8222, Fax: +91-11-42208444

Email: customerservice@lifetechnindia.com, www.atzlabs.com; www.lifetechnindia.com

1. General Description

The Metolachlor ELISA is an immunoassay for the detection of Metolachlor. This test is suitable for the quantitative and/or qualitative detection of Metolachlor in contaminated samples. Samples requiring regulatory action should be confirmed by HPLC, GC/MS, or other conventional methods.

2. Safety Instructions

The standard solutions in this test kit contain small amounts of Metolachlor. In addition, the substrate solution contains tetramethylbenzidine and the stop solution contains diluted sulfuric acid. Avoid contact of stopping solution with skin and mucous membranes. If these reagents come in contact with the skin, wash with water.

3. Storage and Stability

The Metolachlor ELISA kit should to be stored in the refrigerator (4–8°C). The solutions must be allowed to reach room temperature (20-25°C) before use. Reagents may be used until the expiration date on the box.

Consult state, local and federal regulations for the proper disposal of all reagents.

4. Test Principle

The test is a direct competitive ELISA based on the recognition of Metolachlor by specific antibodies. Metolachlor, when present in a sample, and a Metolachlor-enzyme conjugate compete for the binding sites of rabbit anti-Metolachlor antibodies in solution. The Metolachlor antibodies are then bound by a second antibody (goat anti-rabbit) immobilized on the microtiter plate. After a washing step and addition of the substrate solution, a color signal is produced. The intensity of the blue color is inversely proportional to the concentration of Metolachlor present in the sample. The color reaction is stopped after a specified time and the color is evaluated using a microplate ELISA photometer. The concentrations of the samples are determined by interpolation using the standard curve constructed with each run.

5. Limitations of the Metolachlor ELISA, Possible Test Interference

Numerous organic and inorganic compounds commonly found in samples have been tested and found not to interfere with this test. However, due to the high variability of compounds that might be found in samples, test interferences caused by matrix effects cannot be completely excluded. Mistakes in handling the test can also cause errors. Possible sources for such errors can be:

Inadequate storage conditions of the test kit, incorrect pipetting sequence or inaccurate volumes of the reagents, too long or too short incubation times during the immune and/or substrate reaction, extreme temperatures during the test performance (lower than 10°C or higher than 30°C).

The Abraxis Metolachlor ELISA kit provides screening results. As with any analytical technique (GC, HPLC, etc.) samples requiring regulatory action should be confirmed by an alternative method.

A. Reagents and Materials Provided

1. Microtiter plate coated with a second antibody (goat anti-rabbit).
2. Metolachlor Standards (7) and Control (1): 0, 0.1, 0.25, 0.5, 1.0, 2.0, 5.0 ng/mL. Control at 1.5 ng/mL.
3. Antibody Solution (rabbit anti-Metolachlor), 6 mL.
4. Metolachlor-HRP Conjugate Solution, 6 mL.
5. Sample Diluent, 25 mL. Use to dilute samples.
6. Wash Solution (5X) Concentrate, 100 mL.
7. Color (Substrate) Solution (TMB), 12 mL.
8. Stop Solution, 6 mL.

B. Test Preparation

Micro-pipetting equipment and pipette tips for pipetting the standards and the samples are necessary. We recommend using a multi-channel pipette or a stepping pipette for adding the antibody, conjugate, substrate solution and stop solution in order to equalize the incubations periods of the standard solutions and the samples on the entire microtiter plate. Please use only the reagents and standards from one package lot in one test, as they have been adjusted in combination.

1. Adjust the microtiter plate and the reagents to room temperature before use.
2. Remove the number of microtiter plate strips required from the foil bag. The remaining strips are stored in the foil bag and zip-locked closed. Store the remaining kit in the refrigerator (4-8°C).
3. The standard solutions, antibody, conjugate, substrate and stop solutions are ready to use and do not require any further dilutions.
4. Dilute the Wash Buffer at a ratio of 1:5. If using the entire bottle (100 mL), add to 400 mL of deionized or distilled water.
5. The stop solution should be handled with care as it contains diluted H₂SO₄.

C. Assay Procedure

1. Add 50 µL of the **standard solutions and samples** into the wells of the test strips according to the working scheme given. We recommend using duplicates or triplicates.
2. Add 50 µL of **enzyme conjugate solution** to the individual wells successively using a multi-channel pipette or a stepping pipette.
3. Add 50 µL of **antibody solution** to the individual wells successively using a multi-channel pipette or a stepping pipette. Cover the wells with parafilm or tape and mix the contents by moving the strip holder in a circular motion on the benchtop for 30 seconds. Be careful not to spill contents.
4. Incubate the strips for 30 minutes at room temperature.
5. After incubation, remove the covering and vigorously shake the contents of these wells into a sink. Wash the strips **three times** using the 1X washing buffer solution. Use at least a volume of 250 µL of washing buffer for each well and each washing step. Remaining buffer in the wells should be removed by patting the plate dry on a stack of paper towels.
6. Add 100 µL of **color (substrate) solution** to the wells. Cover the wells with parafilm or tape and mix the contents by moving the strip holder in a circular motion on the benchtop for 30 seconds. Incubate the strips for 20 minutes at room temperature. Protect the strips from direct sunlight.
7. Add 50 µL of **stop solution** to the wells in the same sequence as for the substrate solution.
8. Read the absorbance at 450 nm using a microplate ELISA photometer within 15 minutes after the addition of the stopping solution.

D. Evaluation

The evaluation of the ELISA can be performed using commercial ELISA evaluation programs 4-Parameter (preferred) or Logit/Log. For manual evaluation, calculate the mean absorbance value for each of the standards. Calculate the %B/B₀ for each standard by dividing the mean absorbance value for each standard by the Zero Standard (Standard 0) mean absorbance. Construct a standard curve by plotting the %B/B₀ for each standard on the vertical linear (y) axis versus the corresponding Metolachlor concentration

on the horizontal logarithmic (x) axis on graph paper. %B/B₀ for samples will then yield levels in ppb of Metolachlor by interpolation using the standard curve. Samples showing lower concentrations of Metolachlor compared to Standard 1 (0.1 ng/mL) are considered as negative. Samples showing a higher concentration than Standard 5 (5.0 ng/mL) must be diluted further to obtain accurate results.

E. Additional Materials (not delivered with the test kit)

1. Micro-pipettes with disposable plastic tips (10-200 and 200-1000 µL)
2. Multi-channel pipette (10-250 µL) or stepper pipette with plastic tips (10-250 µL)
3. Microtiter plate washer (optional)
4. Microtiter plate reader (wave length 450 nm)
5. Shaker for microtiter plates (optional)
6. Timer
7. Tape or Parafilm

F. Working Scheme

The microtiter plate consists of 12 strips of 8 wells, which can be used individually for the test. The standards must be run with each test. Never use the values of standards which have been determined in a test performed previously.

Std 0-Std 6: Standards:
0; 0.1; 0.25; 0.5; 1.0; 2.0; 5.0 ppb

C: Control: 1.5 +/- 0.3 ppb

Sam1, Sam2, etc.: Samples

	1	2	3	4	5	6	7	8	9	10	11	12
A	Std 0	Std 1	Sam1									
B	Std 0	Std 1	Sam1									
C	Std 1	Std 5	Sam2									
D	Std 1	Std 5	Sam2									
E	Std 2	Std 4	rk.									
F	Std 2	Std 4	rk.									
G	Std 3	C										
H	Std 3	C										

G. Standard Curve

These values are used for demonstration purposes only; do not use these values for your determinations.

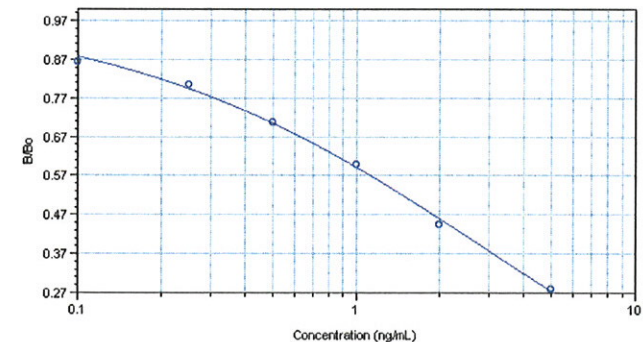

METOLACHLOR Plate, Detailed ELISA Procedure

1. Addition of Standards, Samples

Add 50 μ L of the standard solutions, control or samples into the wells of the test strips according to the working scheme given. We recommend using duplicates or triplicates.

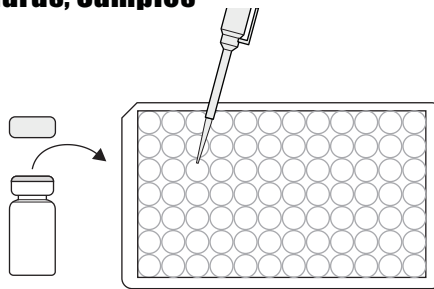

2. Addition of Enzyme Conjugate

Add 50 μ L of the Metolachlor enzyme conjugate to the individual wells successively using a multi-channel pipette or a stepping pipette.

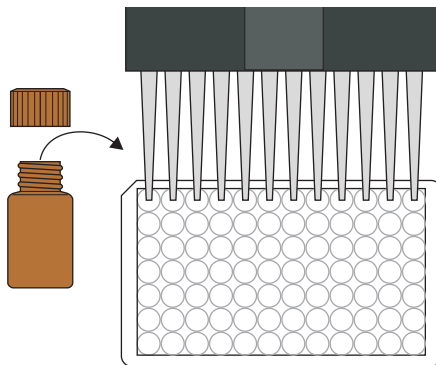

3. Addition of Antibody Solution

Add 50 μ L of the Metolachlor antibody solution to the individual wells successively using a multi-channel pipette. Cover the wells with parafilm or tape and mix the contents by moving the strip holder in a rapid circular motion on the benchtop. Be careful not to spill contents. Incubate the strips for 30 minutes at room temperature.

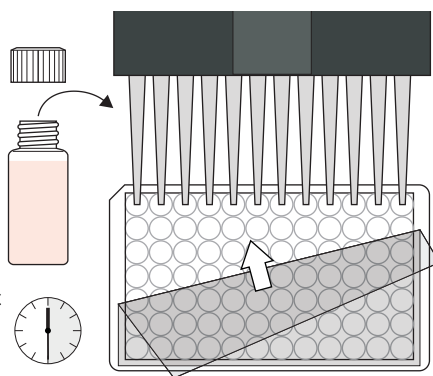

4. Washing of Plates

After incubation, remove the covering and vigorously shake the contents of the wells into a sink. Wash the strips three times with a multi-channel pipette or wash bottle using the diluted 1X washing buffer solution. Please use at least 250 μ L of washing buffer for each well and each washing step. Remaining buffer in the wells should be removed by patting the plate dry on a stack of paper towels.

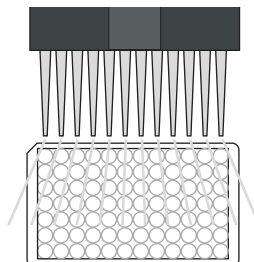

5. Addition of Substrate/Color Solution

Add 100 μ L of substrate/color solution to the individual wells successively using a multi-channel pipette or a stepping pipette. Cover the wells with parafilm or tape and mix the contents by moving the strip holder in a rapid circular motion on the benchtop. Be careful not to spill contents. Incubate the strips for 20 minutes at room temperature away from direct sunlight.

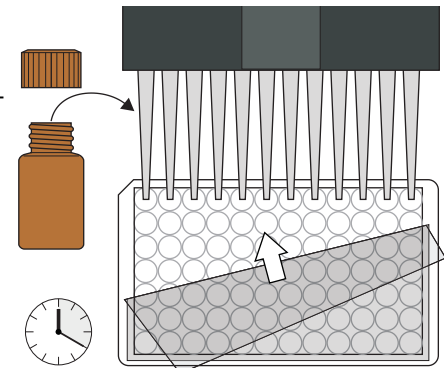

6. Addition of Stopping Solution

Add 50 μ L of stop solution to the wells, in the same sequence as for the substrate solution, using a multi-channel pipette or a stepping pipette.

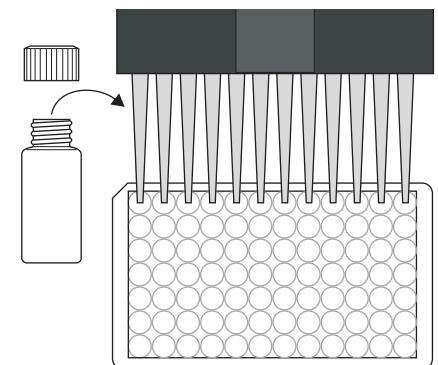

7. Measurement of Color

Read the absorbance at 450 nm using a microplate ELISA reader within 15 minutes. Calculate results.

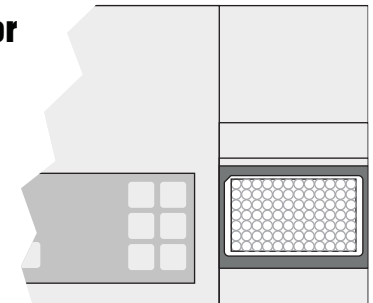

India Contact:

Life Technologies (India) Pvt. Ltd.

306, Aggarwal City Mall, Road No. 44, Pitampura, Delhi - 110034, India
Mobile: +91-98105-21400, Tel: +91-11-42208000, 8111, 8222, Fax: +91-11-42208444
Email: customerservice@lifetechindia.com, www.atzlabs.com; www.lifetechindia.com

METOLACHLOR Plate, Concise ELISA Procedure

1. Addition of Standards, Samples

Add 50 μ L of standard solutions, control or samples.

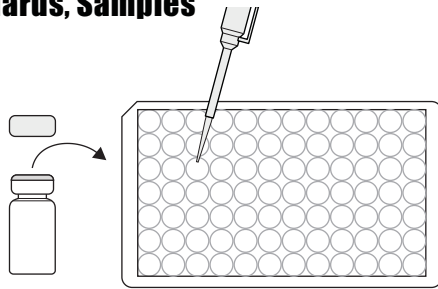

2. Addition of Enzyme Conjugate

Add 50 μ L of enzyme conjugate.

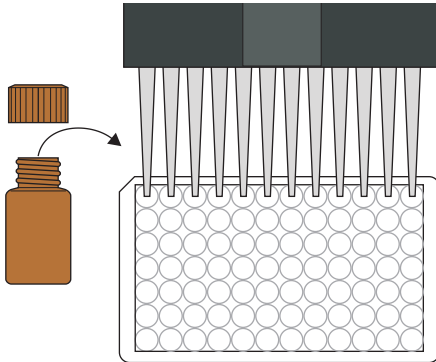

3. Addition of Antibody Solution

Add 50 μ L of the antibody solution. Cover and mix for 30 seconds by moving strip holder in a circular motion on benchtop. Incubate for 30 minutes at room temperature.

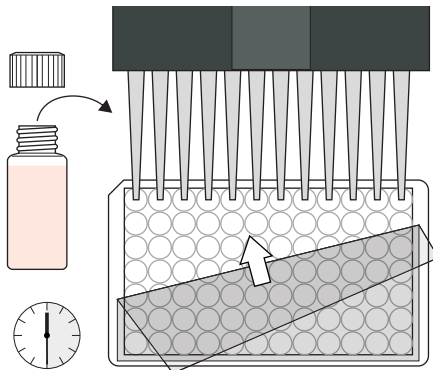

4. Washing of Plates

Wash the wells three times with 250 μ L of diluted 1X washing buffer.

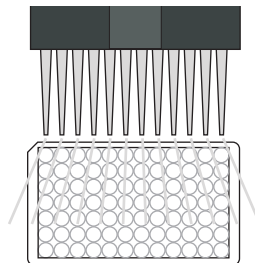

5. Addition of Substrate/Color Solution

Add 100 μ L of substrate/color solution. Cover and mix for 30 seconds by moving strip holder in a circular motion on benchtop. Incubate for 20 minutes at room temperature away from direct sunlight.

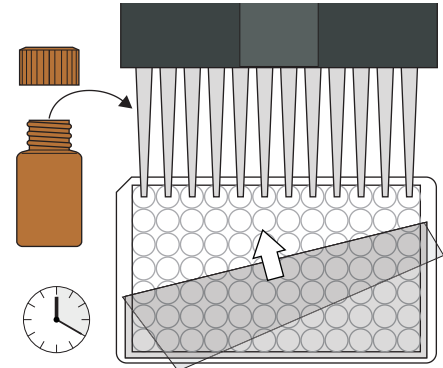

6. Addition of Stopping Solution

Add 50 μ L of stop solution.

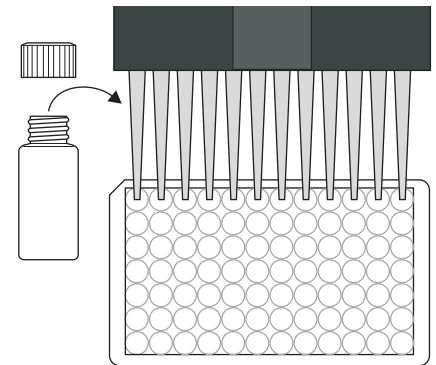

7. Measurement of Color

Measure color at 450 nm within 15 minutes. Calculate results.

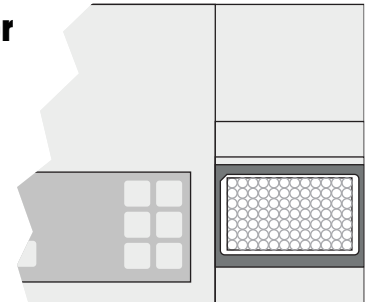

India Contact:

Life Technologies (India) Pvt. Ltd.

306, Aggarwal City Mall, Road No. 44, Pitampura, Delhi - 110034, India
Mobile: +91-98105-21400, Tel: +91-11-42208000, 8111, 8222, Fax: +91-11-42208444
Email: customerservice@lifetechindia.com, www.atzlabs.com; www.lifetechindia.com



Safety Data Sheet

Section 1: Product and Company Identification

1.1 Product Identifiers:

Product Name: Metolachlor Magnetic Particle Kit, Metolachlor Plate Kit

Product Code: 500061, 500065

1.2 Identified Use: Determination of Metolachlor in samples. **Restrictions on Use:** For research use only.

1.3 Company: Abraxis, Inc., 124 Railroad Drive, Warminster, PA 18974 USA, info@abraxiskits.com +1(215) 357-3911, FAX +1(215) 357-5232

1.4 Emergency Telephone Number: +1(215) 357-3911

Section 2: Hazard(s) Identification

2.1 Classification of the mixture: Not a hazardous mixture.

2.2 GHS Label elements, including precautionary statements: Not applicable.

2.3 Hazards not otherwise classified (HNOC) or not covered by GHS: None known.

2.4 Unknown acute toxicity: None known.

Section 3: Composition / Information on Ingredients

3.2 Mixtures: *Contains no hazardous ingredients at levels requiring disclosure by the OSHA Hazard Communication Standard (29 CFR 1910.1200), however it contains minor amounts of materials considered hazardous. We recommend handling all substances with caution.*

Section 4: First Aid Measures

4.1 Description of first aid measures: Consult a physician. Show this safety data sheet to the doctor in attendance. Move out of dangerous area.

If inhaled: If breathed in, move person into fresh air. If not breathing, give artificial respiration. Consult a physician.

In case of skin contact: Wash off with soap and plenty of water. Consult a physician.

In case of eye contact: Rinse thoroughly with plenty of water for at least 15 minutes and consult a physician.

If swallowed: Never give anything by mouth to an unconscious person. Rinse mouth with water. Consult a physician.

4.2 Most important symptoms and effects, both acute and delayed: No data available

4.3 Indication of any immediate medical attention and special treatment needed: No data available. Treat symptomatically.

Section 5: Fire-fighting Measures

5.1 Suitable extinguishing media: Use an extinguishing agent suitable for the surrounding fire.

5.2 Special hazards arising from the substance or mixture: None known

5.3 Advice for firefighters: Wear self-contained breathing apparatus for fire-fighting if necessary.

5.4 Further information: No data available

Section 6: Accidental Release Measures

6.1 Personal precautions, protective equipment and emergency procedures: Use personal protective equipment (see section 8). Avoid dust formation. Avoid breathing vapors, mist, dust, or gas. Ensure adequate ventilation. Evacuate personnel to safe areas.

6.2 Environmental precautions: Prevent further leakage or spillage if safe to do so. Do not let product enter drains. Discharge into the environment must be avoided.

6.3 Methods and materials for containment and cleaning up: Solids (if applicable): Pick up and arrange disposal without creating dust. Sweep up and shovel. Liquids (if applicable): Absorb with liquid-binding material (sand, diatomite, acid binders, universal binders, sawdust). Keep in suitable, closed containers for disposal.

6.4 Reference to other sections: For information on safe handling see section 7.

For information on personal protection see section 8.

For information on disposal see section 13.

Section 7: Handling and Storage

7.1 Precautions for safe handling: See section 2. Avoid inhalation of vapors and contact with skin and eyes. Wear appropriate personal protective equipment. Do not eat, drink, or smoke in work area.

7.2 Precautions for safe storage: Keep container(s) tightly closed in a dry, well-ventilated place. Protect from physical damage. See label or product insert for appropriate storage temperature and additional specific information.

7.3 Specific end use(s): No data available

Section 8: Exposure Controls / Personal Protection

8.1 Control parameters: Not applicable.

8.2 Exposure controls:

Appropriate engineering controls: Provide adequate ventilation. Handle in accordance with good industrial hygiene and safety practice. Wash hands before breaks and at the end of workday. Keep away from food and beverages.

Personal protective equipment: The usual precautionary measures, including eye/face/skin protection, should be taken when handling any chemical. Avoid contact with eyes, skin, and clothing.

Eye protection: As with handling of any chemical, wear approved safety goggles.

Skin protection: Handle with gloves. No specific information regarding glove material or thickness is available, but gloves must be impermeable and resistant to the substance being handled. Gloves must be inspected prior to use. Use proper glove removal technique (without touching glove's outer surface) to avoid skin contact with this product. Dispose of contaminated gloves after use in accordance with applicable laws and good laboratory practices. Wash and dry hands.

Respiratory protection: As with any chemical, where excessive vapor, mist, or dust may result, use a chemical fume hood or approved respiratory protection equipment.

Body protection: Lightweight, protective clothing.

Section 9: Physical and Chemical Properties

9.1 Information on basic physical and chemical properties

Appearance: Multiple

Odor: Characteristic

Odor Threshold: No data available

pH: Multiple

Melting point/freezing point: No data available

Initial boiling point and boiling range: No data available

Flash point: Not applicable

Evaporation rate: No data available

Flammability (solid, gas): No data available

Upper/lower flammability or explosive limits: No data available

Vapor pressure: No data available

Vapor density: No data available

Relative density: No data available

Water solubility: Various

Partition coefficient: n-octanol/water: No data available

Auto-ignition temperature: Not applicable

Decomposition temperature: No data available

Viscosity: No data available

Explosive properties: No data available

Oxidizing properties: No data available

9.2 Other information: No data available

Section 10: Stability and Reactivity

10.1 Reactivity: No data available

10.2 Chemical stability: Stable under recommended storage conditions.

10.3 Possibility of hazardous reactions: No data available

10.4 Conditions to avoid: No data available

10.5 Incompatible materials: No data available

10.6 Hazardous decomposition products: No data available. In the event of fire: see section 5.

Section 11: Toxicological Information

11.1 Information on toxicological effects

Acute toxicity: Not available. To the best of our knowledge, the chemical, physical, and toxicological properties of this product have not been thoroughly investigated.

Inhalation: No data available

Ingestion: No data available

Skin contact: Irritant to skin and mucous membranes.

Eye contact: May cause eye irritation in susceptible persons.

Respiratory or skin sensitization: No data available

Aspiration hazard: No data available

Mutagenicity: No data available

Carcinogenicity

IARC: No component of this product present at levels greater than or equal to 0.1% is identified as probable, possible or confirmed human carcinogen by IARC.

ACGIH: No component of this product present at levels greater than or equal to 0.1% is identified as a carcinogen or potential carcinogen by ACGIH.

NTP: No component of this product present at levels greater than or equal to 0.1% is identified as a known or anticipated carcinogen by NTP.

OSHA: No component of this product present at levels greater than or equal to 0.1% is identified as a carcinogen or potential carcinogen by OSHA.

Teratogenicity: No data available

Reproductive/fertility toxicity: No data available

Specific target organ toxicity, single exposure: No data available

Specific target organ toxicity, repeated exposure: No data available

Section 12: Ecological Information

12.1 Toxicity: No data available

12.2 Persistence and degradability: No data available

12.3 Bioaccumulative potential: No data available

12.4 Mobility in soil: No data available

12.5 Results of PBT and vPvB assessment: No data available

12.6 Other adverse effects: An environmental hazard cannot be excluded in the event of unprofessional handling or disposal.

Section 13: Disposal Considerations

13.1 Waste treatment methods

Product: All waste must be handled and disposed according to local, state, and federal regulations. Avoid disposing large volumes in sewer.

Contaminated packaging: All waste must be handled and disposed according to local, state, and federal regulations.

Refer to sections 7 and 8 for safe handling guidance.

Section 14: Transport Information

UN Number: Not regulated

UN Proper shipping name: Not classified as dangerous in the meaning of transport regulations.

Transport hazard class(es): No data available

Packing group: No data available

Environmental hazard: No data available

Bulk transport: No data available

Special considerations: No data available

Section 15: Regulatory Information

To the best of our knowledge, this product contains no substances which, at their given concentrations, are considered hazardous by other regulatory agencies. Refer to section 3.

Section 16: Other information

This information is based on our present knowledge. While Abraxis , Inc. believes that the data contained herein are factual and the opinions expressed represent a best effort to present accurate information, the data are not to be taken as a warranty or representation for which Abraxis , Inc. assumes legal responsibility. The information shall not be taken as being all-inclusive and is to be used only as a guide. The data are offered solely for the user's consideration, investigation, and verification. These suggestions should not be confused with either state, municipal, or insurance requirements, or with national safety codes and constitute no warranty. Any use of these data and information must be determined by the user to be in accordance with applicable federal, state, and local regulations.

All materials and mixtures may present unknown hazards and should be used with caution. Since Abraxis , Inc. cannot control the methods, volumes, or conditions of use of this product, Abraxis , Inc. shall not be held liable for any damages or losses resulting from the handling or from contact with the product as described herein. An individual technically qualified to handle potentially hazardous chemicals must supervise the use of this material. This product is sold for research use only. It is not for any human or animal therapeutic or clinical diagnostic use.

Date this SDS was prepared: 5/20/2016

Version: 2

Changes from previous version: Abraxis, LLC changed to Abraxis, Inc.